

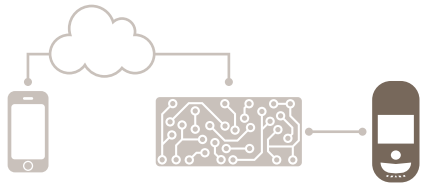

Paradox *Insight*[™]
Designed for your lifestyle

HD77



Installation Guide

Revision 1.00

P ▲ R ▲ D O X[™]

paradox.com

Warranty

For complete warranty information on this product please refer to the Limited Warranty Statement found on the website www.paradox.com/terms. Your use of the Paradox product signifies your acceptance of all warranty terms and conditions. Please ensure compliance with the applicable laws of local jurisdictions including privacy laws.

© 2014 Paradox Ltd. All rights reserved. Specifications may change without prior notice. Canadian and international patents may apply. EVOHD Digiplex is a trademark or registered trademark of Paradox Ltd. or its affiliates in Canada, the United States and/or other countries. LODIFF® is a registered trademark of Fresnel Technologies Inc.

For the latest information on products approvals, such as UL and CE, please visit www.paradox.com.

Note: This hardware or software product (“product(s)”) and its related documentation are provided by Paradox for use complying with all local, national, and international laws. any express or implied warranties, including, but not limited to, the implied warranties of merchantability, fitness for a particular purpose and noninfringement are disclaimed. In no event shall Paradox be liable to any customer or third party for any direct, indirect, special, exemplary, or consequential damages of any kind (including, but not limited to, payment for procurement of substitute goods or services; loss of property, data, or profits; or business interruption) however caused and on any theory of liability, whether in contract, strict liability, or tort (including negligence or otherwise) arising in any way from the use of the product(s) and related documentation.

This product is manufactured in Canada.

Paradox
780 Industrial Boulevard
St-Eustache, Quebec
Canada, J7R 5V3
Tel: (450) 491-7444
Fax: (450) 491-2313

Contents

Warranty	2
Contents	3
Chapter 1 Introduction	4
1.1 HD77 Key Features	4
1.2 Overview	5
1.3 LED Status Indicators	5
Chapter 2 Hardware Installation	7
2.1 Requirements	7
2.2 Location and Mounting	8
2.3 Installation Using the Pre-assembled Swivel Bracket	9
2.4 HD77 Installation (Wall or Corner Mount)	12
Chapter 3 Configure IP Router	16
3.1 Setting Up the Router for Port Forwarding	16
3.2 Reserve the IP or Bind the IP to a MAC	21
Chapter 4 HD77 Programming	22
4.1 PIR programming Through BabyWare	22
4.2 System Programming Through BabyWare	24
4.3 Registering your Customer's System with ParadoxMyHome	30
4.4 Upgrading Firmware	32
Chapter 5 Insight Application Configuration	34
Appendix: A Specifications	35
HD77 Specifications	35
Appendix: B PIR Detector Beam Pattern	36
Appendix: C Certifications	37
Appendix: D Unassemble Swivel Bracket	38
Disassemble Swivel	38

Introduction

The Paradox HD77 is an HD video & audio camera with superior PIR detector. HD77 is a high-performance HD 720p color camera, and a microphone with an integrated PIR detector. It offers superior motion detection with video verification, for areas up to 12m x 12m (40ft x 40ft).

The HD77 enables streaming Video On Demand (VOD) and Record On Demand (ROD) functionality using the Insight Application. Video and JPEG outputs can be sent to the IPRS-7 monitoring software and to the user's email to help determine the cause of an alarm, and apply an appropriate response to the situation.

The HD77 provides 24/7 continuous monitoring of your property. The high definition digital video camera transmits a color signal at 360p resolution during normal light conditions. During periods of low light the HD77 supplies IR illumination that supports the HD77 camera down to zero lumens of light with black and white signal transmission.

The high quality microphone supplements the video with superior quality audio.

The system's master user can ensure privacy by setting viewing rights by user. This can be done through the Paradox Insight app. The HD77 also increases privacy and security by storing video recordings within the module. This way any recordings are more secure than video files stored on a public or private server. The module only records upon a detection event or when Record On Demand is enabled.

The HD77 is user-centered and respects user privacy. There are 2 levels of authorization. The lower level authorized users receive 15 minutes of viewing after an alarm. The higher level authorized users have unlimited viewing and authorization to Record On Demand.

Recording only takes place when an alarm is triggered, or when an authorized user implements Record On Demand. Each time ROD is enabled the recording is limited to 5 minutes. Images sent to the CMS include only those from actual alarm events, as defined during installation. Recordings of events remain in control of the user and are stored within the HD77 device. The master user can download the recordings at his convenience and to his preferred files location.

1.1 HD77 Key Features

- HD 720p 1.4 Mega Pixel color image sensor
- Video and Audio H.264 streaming for VOD and ROD
- Paradox patented PIR technology
- Video verification of an alarm event viewable by IPRS-7/CMSI or the Mobile application
- Integrated email client to send notification of events as video and/ or images
- Multiple simultaneous multimedia streams
- Event file names and video file names are linked through the naming convention for easy identification
- Auto Gain Control, Auto White Balance, Auto Exposure
- Zero-lux vision using high power IR LEDs
- Choice of either IR LEDs or white LEDs for low light illumination
- Microphone for high quality sound transmission
- 4 GB Micro SD card
- Digibus connection to Paradox EVOHD Panel
- LAN connection

1.2 Overview

The Paradox HD77 is an HD video and audio camera with a superior PIR detector.

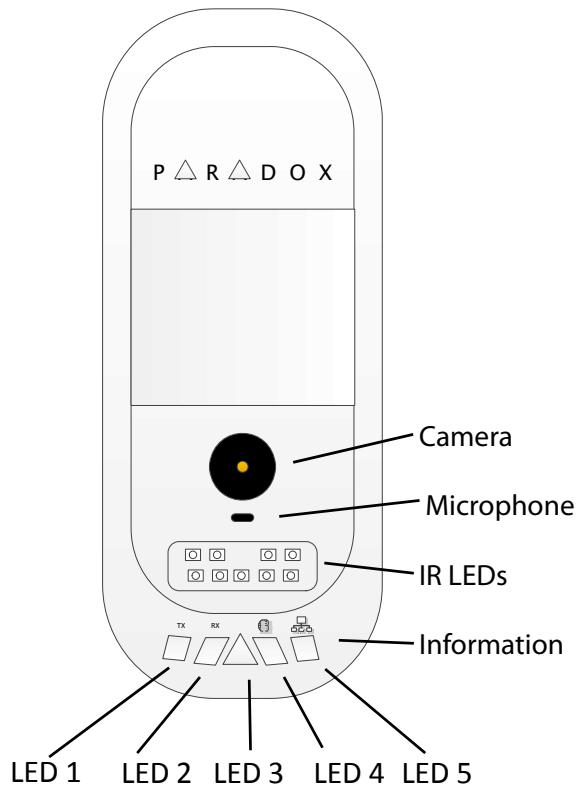

Figure 1 – Front view

1.3 LED Status Indicators

The following table describes the HD77 LEDs and their functionality.

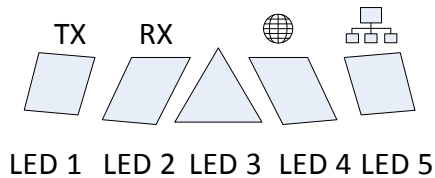

Figure 2 – LED Arrangement

LEDs 1, 2, 4, and 5 are used for installer diagnostics. These LEDs are active after boot up, when the lock mechanism is opened.

LED	Functionality	LED assignment
LED1	Data TX	Flashing green = data transmission Off = No data
LED2	Data RX	Flashing green = data reception Off = No data
LED3 (both with the case locked and unlocked)	HD77 module is up and running. There are currently no alarms or requests for VOD/ROD.	OFF
	Firmware upgrade in progress	Flashing Purple
	VOD (no PIR detection)	Blue on
	Power-up (PIR stabilization and CPU not fully ready – waiting for all labels)	Flashing Blue
	Locate mode	Flashing Blue
	General bus failure, wiring problem, too many modules communication problem	Red on
	Bus low power	Flashing Red
	PIR alarm	Red for 5 sec
LED4	Active Web connection	Green
LED5	100MB/10MB link 100MB/10MB data TX or RX	Green = LAN Active Off = No Connection Flashing green on data

Important - LED3: PIR indication can be set to On or Off by the installer, however, the VOD indication can be turned off only by the master user using the Insight application.

Turning the VOD LED off may be considered in some countries as a violation of applicable laws. Make sure to install the HD77 according to Local Laws.

Hardware Installation

This section explains the hardware requirements and mounting instructions.

2.1 Requirements

Before you start the installation make sure you have all of the required infrastructure, tools and software.

2.1.1 Hardware

Note: A single CAT5 or higher cable can be used to wire a single HD77 camera. This cable includes 2 twisted pairs for the 4-wire combus and 2 twisted pairs for the Ethernet lines. When using this option the cable length is limited to 50 meters. When using this option the cable length is limited to 50 meters.

Note: An alternate wiring scheme is to wire the HD77 with two separate cables. 1 Ethernet cable and 1– 4-wire combus.

In order to take full advantage of all that the Insight Solution has to offer ensure that the mounting location has the following infrastructure:

- 4-wire combus cable that connects to the EVOHD
- Ethernet line that connects to a router or Ethernet switch
- a router with enough ports to connect all of the cameras (1 port for each camera) plus 1 port if you are using an IP150, 1 port for your computer, and 1 port for the incoming internet connection
If the router does not have enough ports you will also need a switch.

The router will need to be configured for port forwarding for the HD77. Each HD77 in the system will have a different IP address and each one will need port forwarding to two ports of its IP address. One from the external IP address:port (any port above port #1024) to the internal <IP address>:80 and one for <IP address>:443.

The installer will also need to have the following job specific tools and equipment:

- a laptop with Windows 7
- a connection from your laptop to the system either by:
 - 307USB cable
 - OR
 - IP150 Internet module to connect to the EVOHD serial port

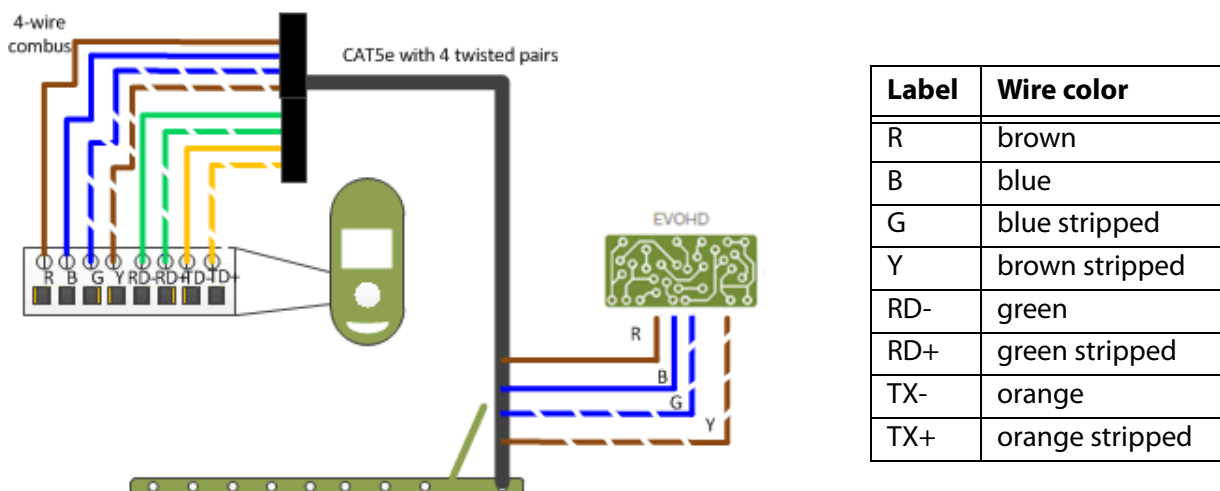

Figure 3 – Recommended wiring for using the one CAT5 or higher cable

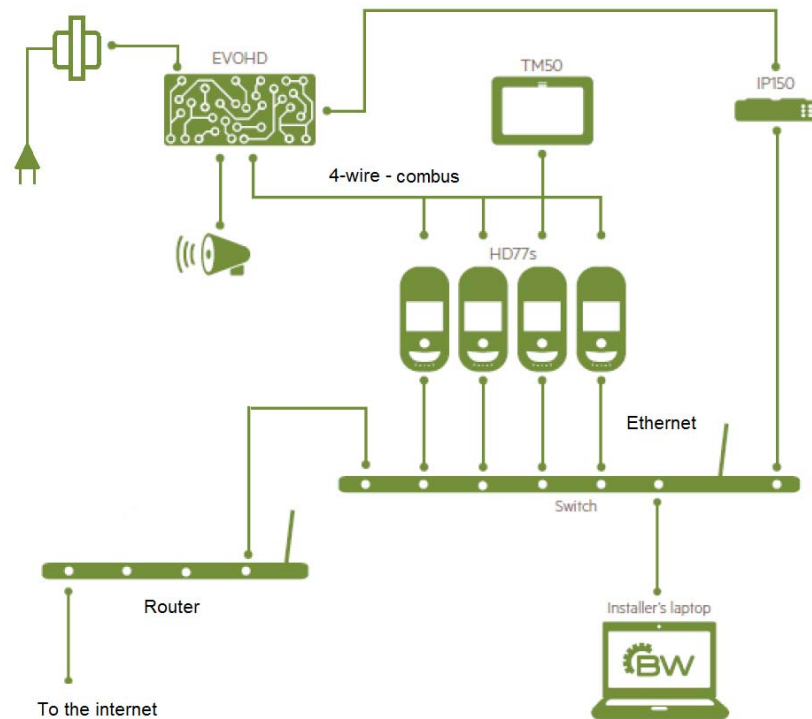

Figure 4 – HD77 Hardware Connections

2.1.2 Software

The installer will also need to have the following software available on his laptop.

- BabyWare Installer software V 2.5 or higher (downloadable from paradox.com)
- Paradox IP Exploring Tool V1.66 or higher (downloadable from paradox.com)

2.2 Location and Mounting

Follow the recommendations and cautions in order to get the most out of your system.

2.2.1 Recommendations

- Install the device at a height between 2.1m to 2.7m (7ft to 9ft), allowing a minimum gap of 2cm (~1 in) from the ceiling (to allow for opening/closing of the cover).

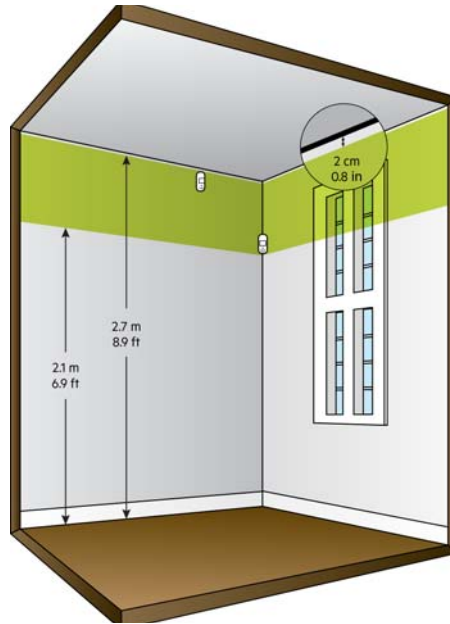

Figure 5 – Mounting Guidelines

- Install the device in a location where the detector and camera's field of view is clear of any obstacles.
- For LAN connection, use a CAT5e/CAT6 Ethernet cable (70m Max.) between the HD77 and the router.
- Mount the module so that walking traffic cuts across the beam pattern.

2.2.2 Cautions

- Do not install the device near objects causing temperature changes such as heaters, refrigerators and ovens.
- Do not install the device in the path of air flow from vents, fans or windows.
- Do not install the device in the path of reflective surfaces, direct sunlight or infrared light.
- Do not install the device where it is exposed to oil vapors or steam.
- Do not touch the sensor surface or the camera lens as this could result in a detector malfunction.

2.3 Installation Using the Pre-assembled Swivel Bracket

This swivel bracket is capable of:

- sweep angle from left to right of 90 degrees
- angle of declination (up and down) is 15 degrees.

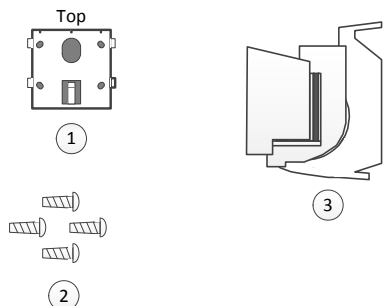

Part #	Description
1	Wall plate
2	4 self tapping screws #6 B type
3	Pre-assembled swivel bracket

Figure 6 – HD77 Swivel Bracket Parts

1. Unlock the cover of the camera.
2. Separate the Module from the back cover of the HD77 by carefully pulling out and sliding up.

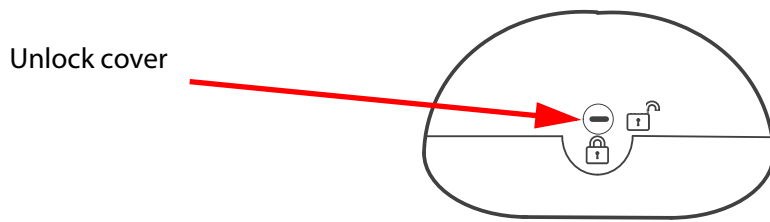

Figure 7: Separating the Module from the Camera Housing

3. Pull the cable(s) through the wall plate (part #1) and screw the wall plate to the wall (screws and anchors are not supplied). The upper screws must be at least 3"(7.62cm) from the ceiling.

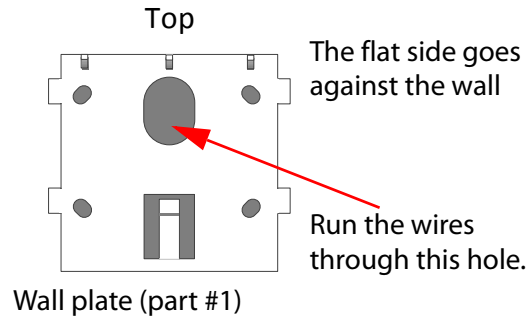

Figure 8: Install the Wall Plate (part #1)

4. Angle the camera mount 15 degrees down to facilitate cable insertion. Pull the cables through the assembled swivel bracket.

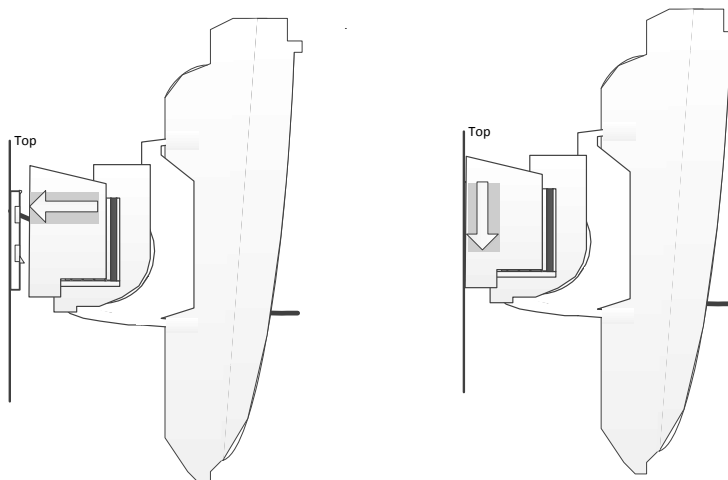
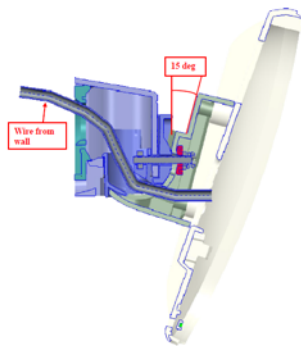

Figure 9: Run the Cable through the Swivel Assembly

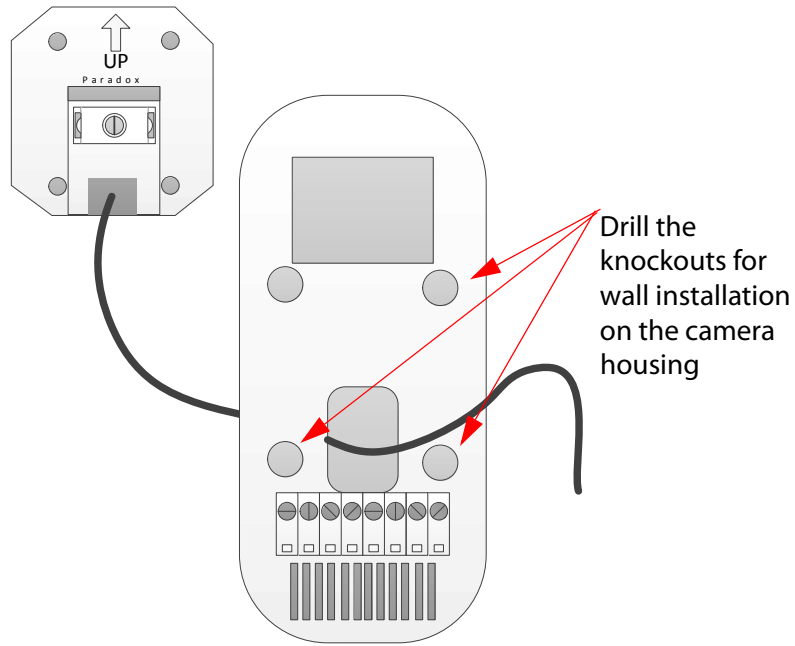

Figure 10 – Screw on Camera Back Plate to Swivel.

5. Drill the knockouts for wall installation on the camera housing.
6. Write the serial number of the module into your module table. Include the exact location of this module. If you are using BabyWare the serial number will be displayed, but you will need to write down the correct location for each module according to the serial number.
7. Screw the HD77 back plate to the housing mount using the 4 self tapping screws.

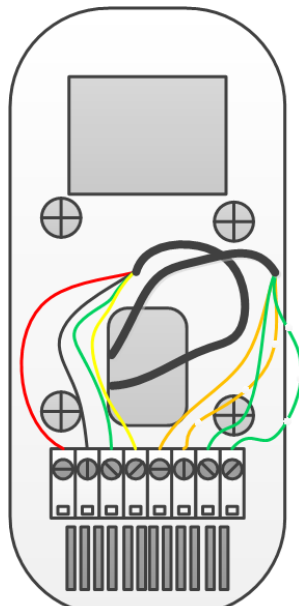

Figure 11 – Wire the Camera

8. Connect the combus wires and the Ethernet wires. See *Figure 13* and *Figure 14* for wiring instructions.

Note: Slack wire should not interfere with closing the cover.

9. Close and lock the camera into the camera housing:

- Step 1. Install the top of the unit first.
- Step 2. Close the HD77 onto the back plate.
- Step 3. Close the lock mechanism at the bottom of the device. (note that by securing the lock, the technician indication LEDs will be turned off).

10. Connect the Ethernet line to the router (if not already connected). Make sure the router is turned on.

11. Adjust the camera position and confirm camera view using Babyware.

2.4 HD77 Installation (Wall or Corner Mount)

1. Separate the front from the back plate of the HD77:

- Step 1. Open the lock mechanism at the bottom of the device.
- Step 2. Pry the cover off from the bottom of the unit.
- Step 3. Lift the front cover up and away. On the back of this module you will see the serial number.
- Step 4. Knock out the appropriate holes on the back plate. Use an awl or an ice pick.
- Step 5. Write the serial number of the module into your module table. Include the exact location of this module. If you are using BabyWare the serial number will be displayed, but you will need to write down the correct location for each module serial number.

2. Ensure to include the wall tamper knockout for the installation.

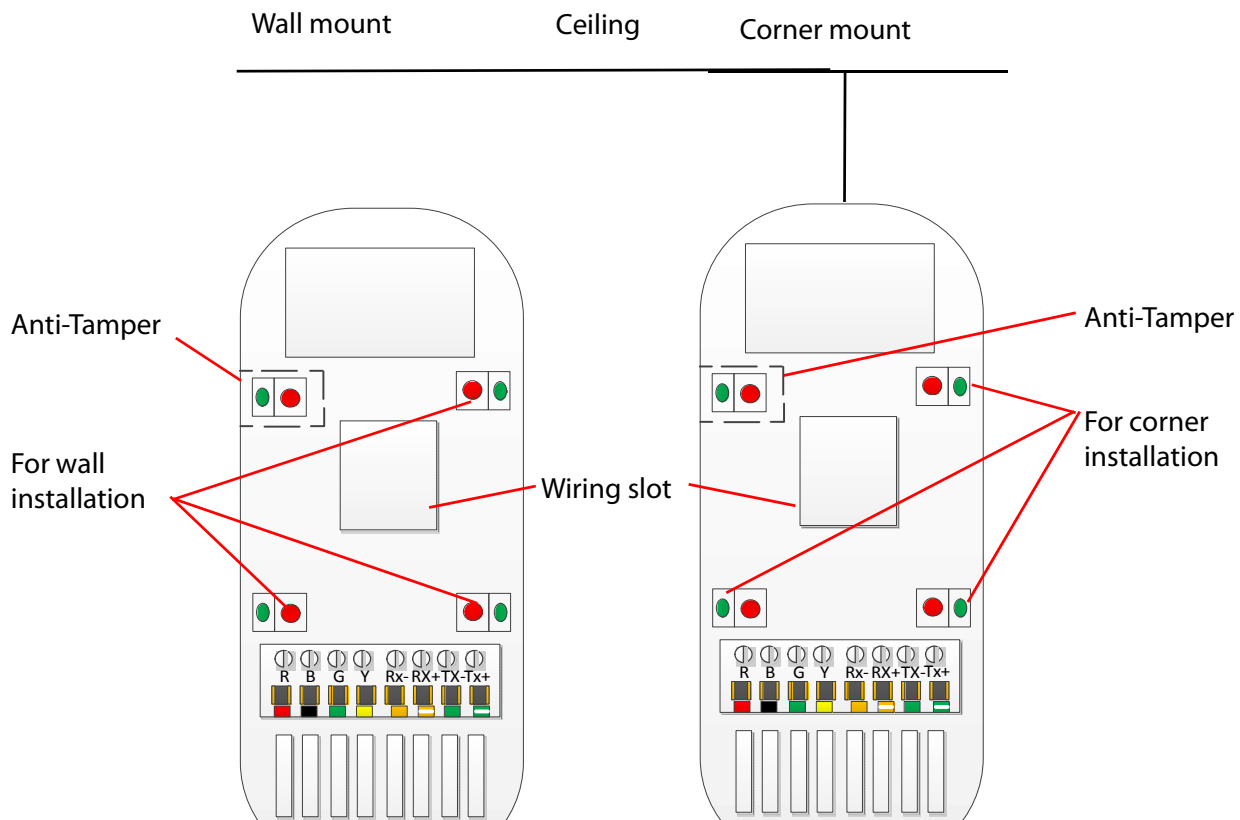

Figure 12 – Knockout Locations

3. Secure the back plate to the wall at the location:

- Step 1. Install the device a minimum of 2cm (~1 in) from the ceiling, between 2.1m and 2.7m off the floor.
- Step 2. Insert the Ethernet and 4-wire combus cables through the wiring slot of the back plate.
- Step 3. Secure the back plate to the wall with screws. (use wall anchors if required).
- Step 4. Ensure that the wall tamper knockout is secured to the wall.
- Step 5. Wire up both the 4-wire combus and the Ethernet cable.
- Step 6. Connect the wires to the terminal board as seen in *Figure 14 on page 14* and *Figure 13 on page 13*.

Note: A single CAT5 or higher cable can be used to wire a single HD77 camera. This cable includes 2 twisted pairs for the 4-wire combus and 2 twisted pairs for the Ethernet lines. When using this option the cable length is limited to 50 meters. When using this option the cable length is limited to 50 meters.

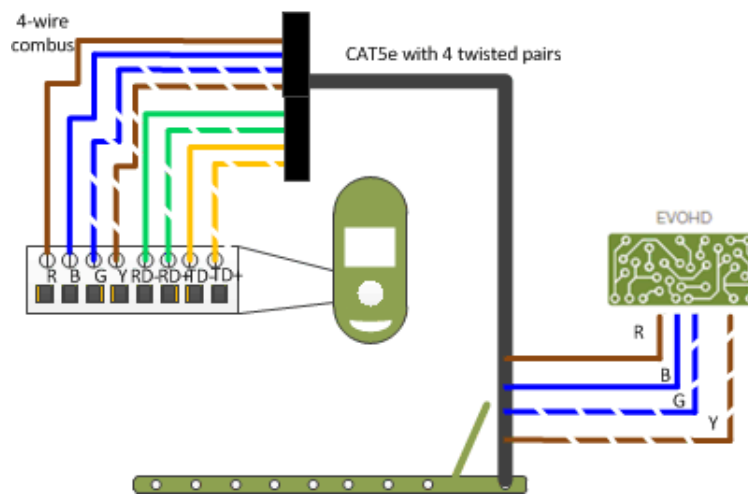

Figure 13 – Recommended wiring for using the CAT5 or higher cable option.

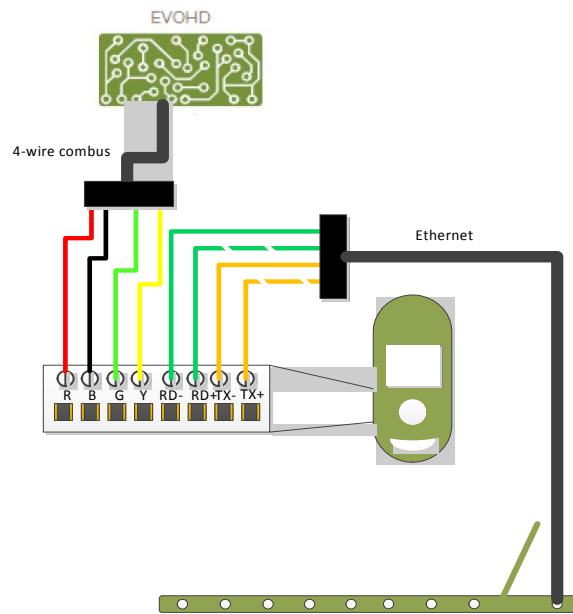

Figure 14 – HD77 2 Cables Wiring

Note: These are 2 separate cables going to two different locations. One cable to the router and one cable to the EVOHD.

Step 7. Slack wire should not interfere with closing the cover.

4. Place the front cover onto the back plate:
 - Step 1. Install the top of the unit first.
 - Step 2. Close the HD77 onto the back plate.
 - Step 3. Close the lock mechanism at the bottom of the device. (note that by securing the lock, the technician indication LEDs will be turned off).
5. Connect the Ethernet line to the router (if not already connected). Make sure the router is turned on.
6. Connect the Ground from the power line to the metal box and to the GND connector on the EVOHD board. If a plastic box is used connect the power ground to the GND connector on the EVOHD board directly.

Warning: Connect the box and board to a valid ground connection.

7. After the whole system hardware is connected power up the system by connecting the power lines from the 16V AC transformer to an outlet.

Note: This outlet must not have any in-line switches!

8. The system will boot-up including the HD77s.
The HD77 boot-up is indicated by LED3. The LED will flash blue for up to 3 minutes.

Configure IP Router

With the IP150 and Cameras wired to the router, perform the port forwarding and reserve the IP addresses of the IP150 and the HD77cameras.

Determine if this job site has a network administrator. See if he is able to assist you in this part of the installation.

Note: This procedure is dependent upon the individual router and network security for the end user's system. The end user's router may require a different procedure.

The following provides an example for one type of router. Refer to the router manufacturer's documentation for detailed instructions. If the end user does not have his router documentation you can find the correct instructions on the internet.

3.1 Setting Up the Router for Port Forwarding

Following is an **example** of instructions for port forwarding.

Note: The end users specific router may require different instructions.

EXAMPLE:

1. Ensure that the router is connected properly as indicated in the router's instructions.
2. Access your router's configuration page:
 - Step 1. Refer to your router's manual for the exact procedure. In most cases, this is done by entering the router's IP address in the address bar of your web browser. Your router's IP address may be indicated in the router's instructions or on a sticker on the router.
 - Step 2. If you cannot find the IP address of the router, try the following from your Windows Screen:
 - Step a. Open a command prompt window. Press the windows button on your keyboard. In the search programs and files window type in Command.
 - Step b. Select Command Prompt.
 - Step c. At the prompt Type **ipconfig**
 - Step d. Press Enter.
The router IP address will be the **Default Gateway :xx.xx.xx.xxx**

```
Administrator: Command Prompt
Microsoft Windows [Version 6.1.7601]
Copyright (c) 2009 Microsoft Corporation. All rights reserved.
C:\Users\Paul>ipconfig
Windows IP Configuration

Ethernet adapter Local Area Connection:

    Connection-specific DNS Suffix  . : lan
    Link-local IPv6 Address . . . . . : fe80::e19e:9a4c:3816:ee84%11
    IPv4 Address. . . . . : 10.0.0.216
    Subnet Mask . . . . . : 255.255.255.0
    Default Gateway . . . . . : 10.0.0.138

Tunnel adapter isatap.lan:

    Media State . . . . . : Media disconnected
    Connection-specific DNS Suffix  . : lan

Tunnel adapter Local Area Connection* 11:

    Media State . . . . . : Media disconnected
    Connection-specific DNS Suffix  . :

Tunnel adapter Teredo Tunneling Pseudo-Interface:

    Connection-specific DNS Suffix  . :
    IPv6 Address. . . . . : 2001:0:5ef5:79fb:812:2fc4:f5ff:ff27
    Link-local IPv6 Address . . . . . : fe80::812:2fc4:f5ff:ff27%14
    Default Gateway . . . . . : ::

C:\Users\Paul>
```

Figure 15 – Command Prompt ipconfig

- Step e. Enter this IP address into the address bar at the top of the browser page. Press **Enter**.
 - Step f. Put in the user name and password. If you do not know the user name and password, go to the site **www.routerpasswords.com** and select your router manufacturer and model. The default user name and password should be listed.
- Step 3. For this instruction sheet, we will use 10.0.0.138 as an example, since it is the router IP address seen in *Figure 15*.

3. In the router's configuration page, check the DHCP settings:

Step 1. If DHCP is enabled, verify that the IP address range is large enough to accommodate all of your cameras. Four cameras will require 4 IP addresses.

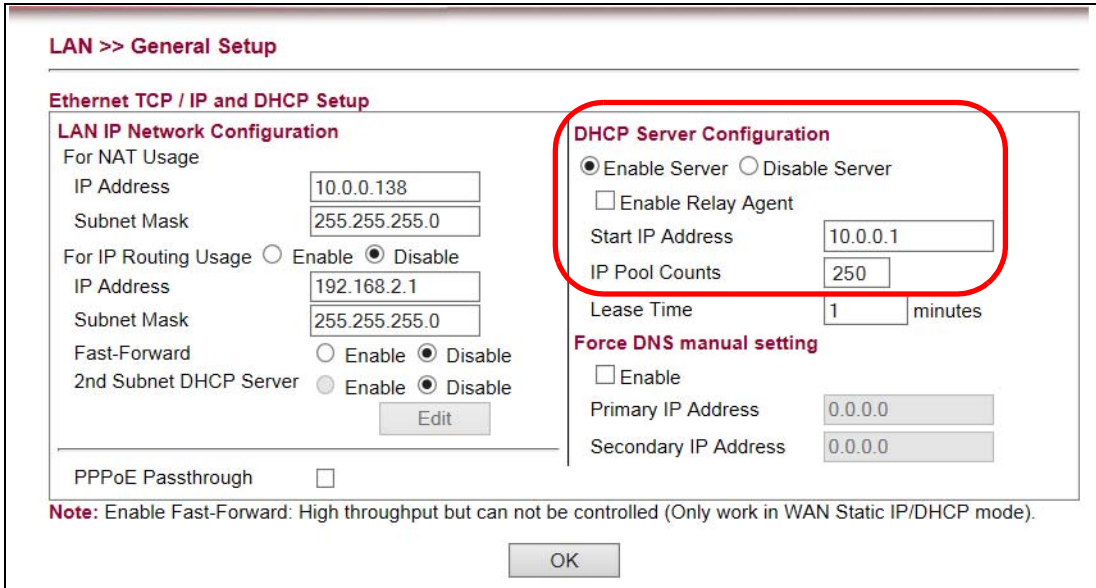

Figure 16 – DHCP Enable

Step 2. Record one address at the upper end of the DHCP range for each HD77 in your system. You will need two ports for each IP address one port for (port 80) for HTTP and one port for (port 443) for HTTPS.

Step 3. DHCP Settings (screenshot may differ depending on type of router used).

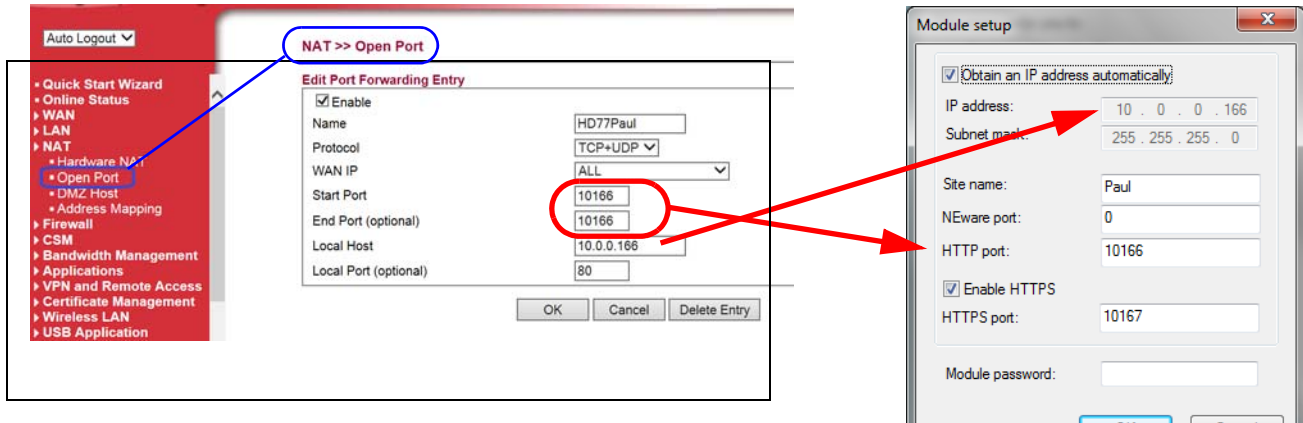

Figure 17 – Port Forwarding

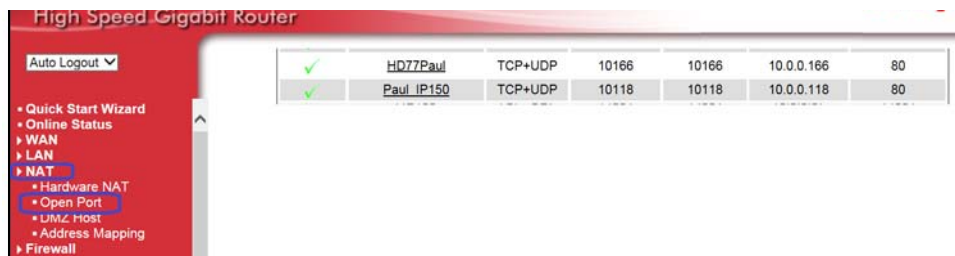

Figure 18 – Fill in the Port Forwarding Information

4. In the router's configuration page, go to the Port Forwarding section (also known as "port mapping", "NAT", (network address translation), or "port redirection").
5. Select an available port on the router and assign it to the HD77 camera. Select a port above #10000 for the external port. This will be internal port 80 on the camera side. For example, set the router port number to 10166 (assuming that it is available) to HD77 port 80. The HD77 IP address according to the IP Exploring tool is 10.0.0.166:10166.
6. Repeat the procedure using the same IP address, select the next consecutive port and assign it to port 443 for HTTPS.

Note: As a suggested standard try to assign the port so that it has 10 + the last section of the IP address. In step 5 above notice that The IP address is 10.0.0.166 and the port # is 10166. The port number is chosen arbitrarily by the installer. Choosing the port number to match the IP address will make configuration easier.

Example of IP addresses and ports for 4 cameras.

Camera name	Location	IP Address	External port number	Internal port number
Living room	facing front door	10.0.0.166	10166	80
			10167	443
Den	facing sliding rear door	10.0.0.168	10168	80
			10169	443
Safe room	facing the safe	10.0.0.170	10170	80
			10171	443
2nd floor	looking down the staircase	10.0.0.172	10172	80
			10173	443

Note: Each camera needs a separate IP address and matching external port.

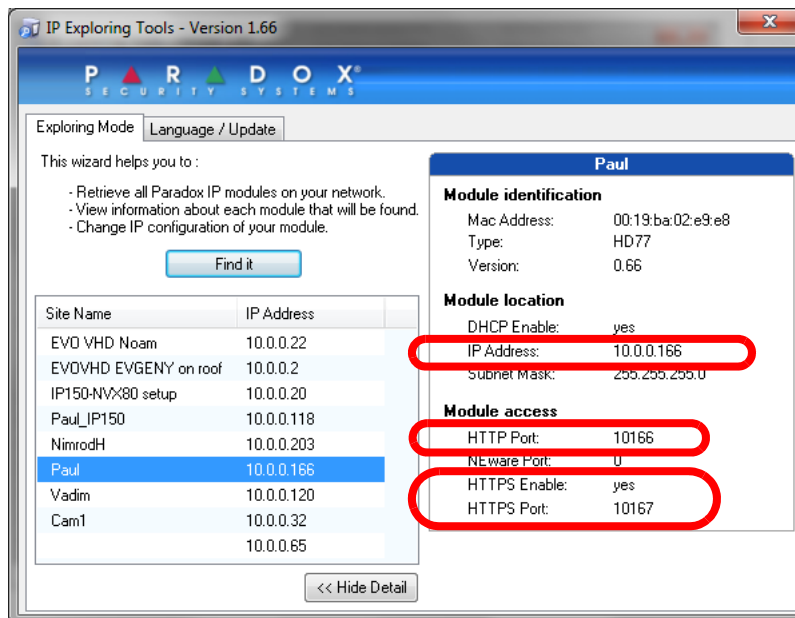

Figure 19 – HD77 IP Address

Note: The IP Exploring tool must be closed before you try and connect to the EVOHD panel through BabyWare.

3.2 Reserve the IP or Bind the IP to a MAC

You need to bind the IP address of the HD77 to a MAC address in your router. This is called reserving an IP address or binding an IP address.

This is done on the router, just like you connected to the router for port forwarding you will need to connect for reserving a port. This should be under the LAN properties.

Since each router is different you may need to use the router user manual or search online for instructions for your particular router.

You can also try searching the internet for videos on routers and reserving IP addresses (screenshots may differ depending on type of router used).

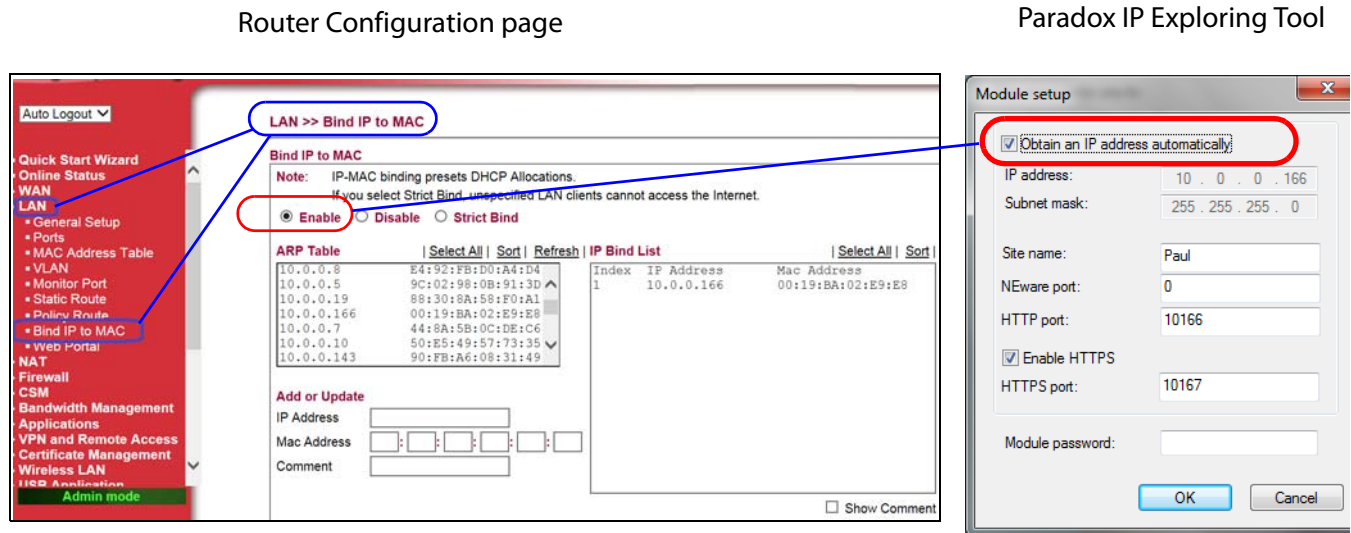

Figure 20 – Binding or Reserving a Port

Once the IP is successfully reserved:

1. Make sure that you are disconnected from BabyWare.
2. Open the IP Exploring Tool.
3. Right click the HD77 camera.
4. Select Module Setup.
5. Check the box for "Obtain an IP address automatically". This means that DHCP is enabled.
6. Put in the Module password [**paradox**].
7. Click **OK**.

HD77 Programming

All PIR parameters of the HD77 can be configured by the installer using the TM50 touchpad, the K641 plus keypad, and by using BabyWare software. Server parameters must be programmed through BabyWare, only.

Note: To program the module sections from any keypad BabyWare must be disconnected from the system.

Note: ALWAYS DO A READ before programming.

4.1 PIR programming Through BabyWare

1. In BabyWare under the Security Modules double click the **HD77** modules or right click the **HD77** module and Click **Properties**. The HD77 Programming screen appears.

Note: Due to our constant efforts to improve our products the software screen grabs may not be exactly the same as your screen.

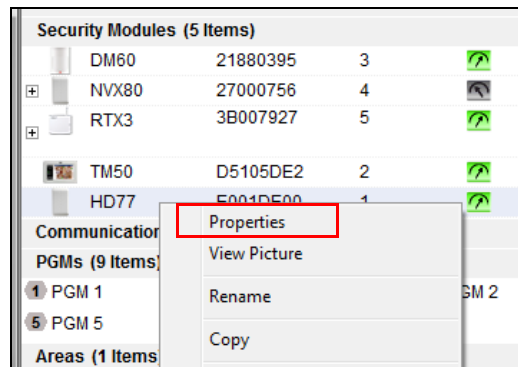

Figure 21 – BabyWare Main Screen

Note: This may take up to 1 minute.

2. Wait for the properties to appear.
3. Use VOD to verify Camera vision / image / angle.
In BabyWare => HD77 Properties => Video tab => play button

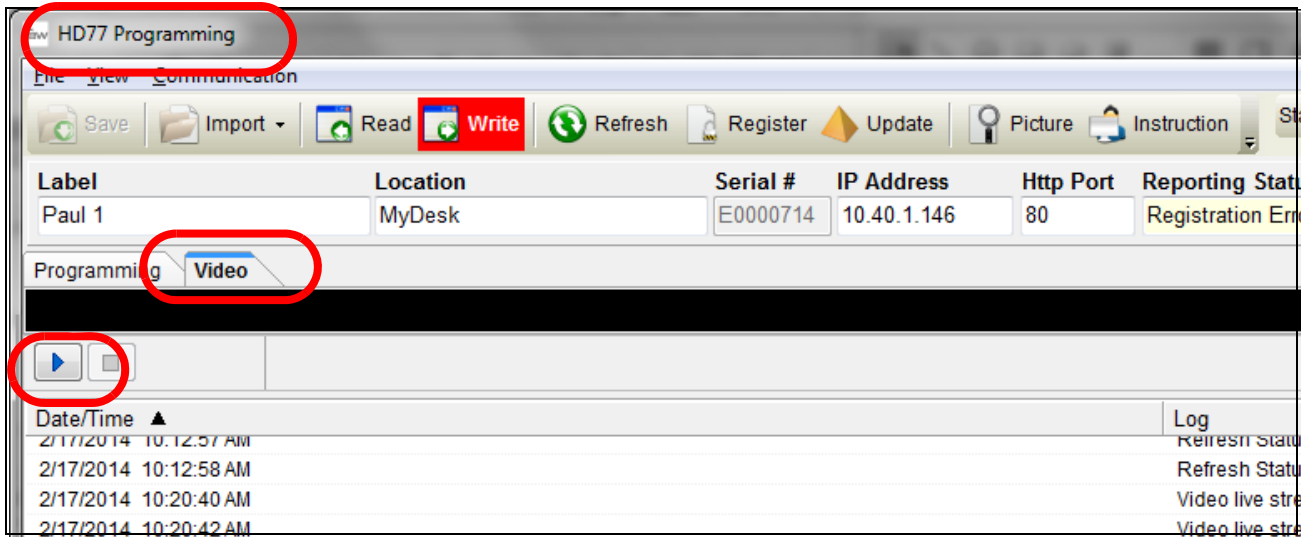

Figure 22 – HD77 Video Stream in BabyWare

4. Configure PIR settings.

Note: Always do a Receive Programming before configuring.

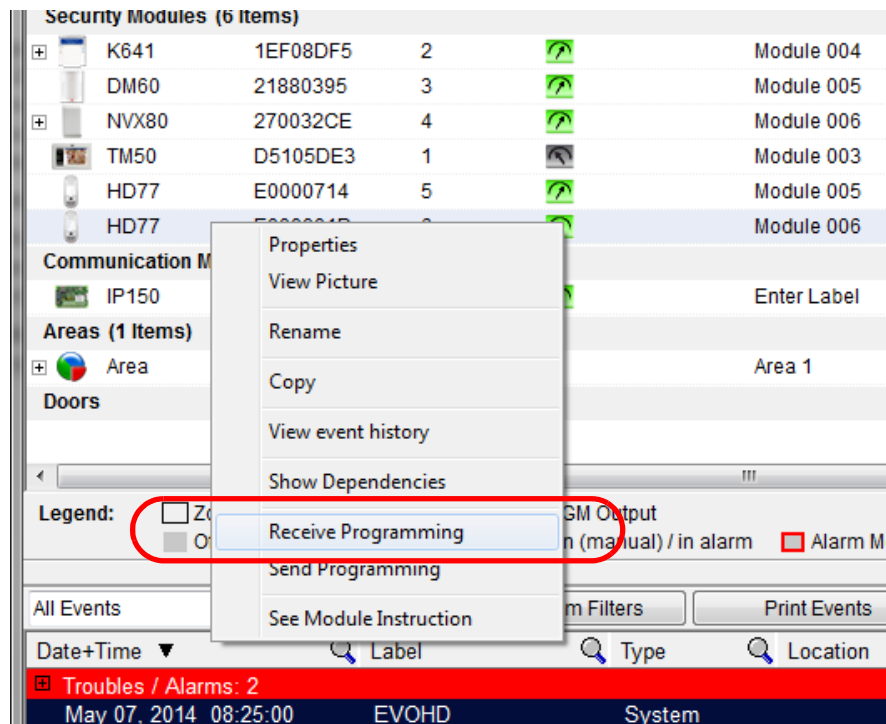

Figure 23 – Receive Programming

5. Select the configuration parameters (See Figure 24 on page 24):
 - Show PIR LED *Check this box to activate LED#3 to display when PIR motion is detected LED#3 lights up Red. When this box not checked LED#3 stays off when PIR motion is detected.* – Default is on.
 - PIR sensitivity level – Default is #3.
 - Sensitivity level 1 is low sensitivity, useful for a room with large windows, or a small room.
 - Sensitivity level 5 is high sensitivity, useful for a large room with small windows.
 - PIR Security level – Default is Normal.

Sensitivity level "Normal" is low sensitivity, useful for a room with large windows, light curtains that may move when the window is open, or a room with windows on the sunny side of the house.

Sensitivity level "High" is high sensitivity, useful for a large room with small windows not on the sunny side of the house, big heavy curtains.

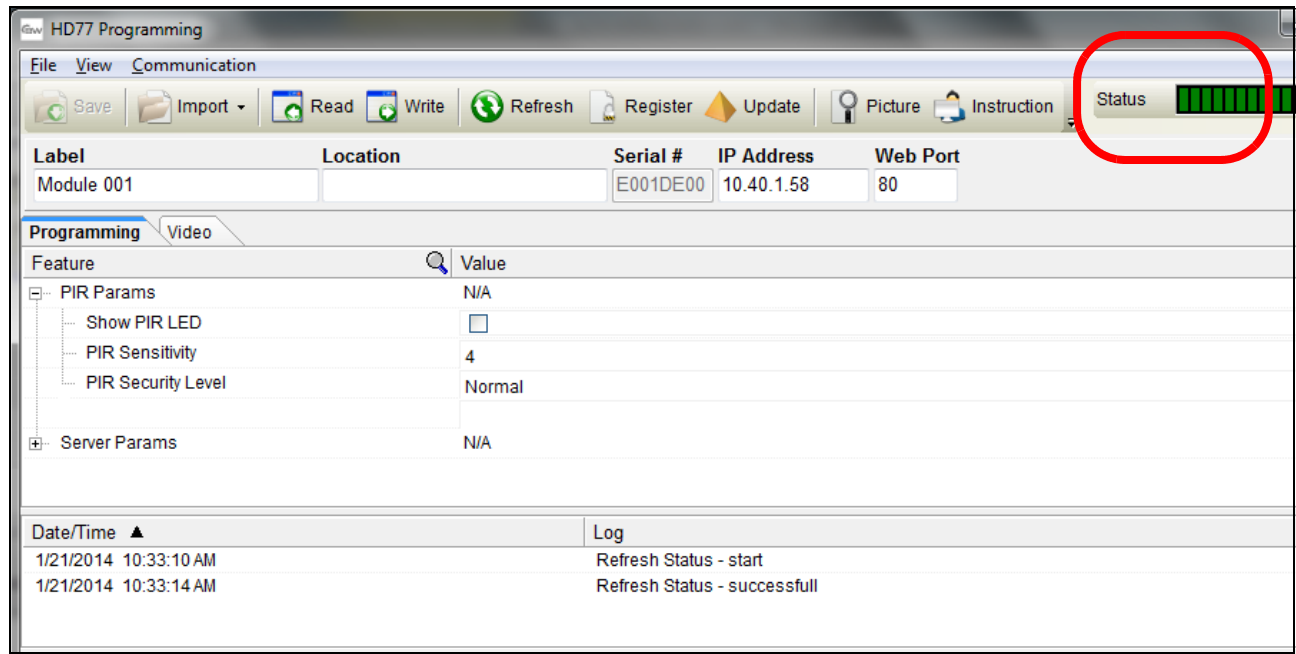

Figure 24 – PIR Parameters

6. Perform a walk test to verify that detection is good.

4.2 System Programming Through BabyWare

Note: Every parameter configurable through the programming guide is accessible and configurable through BabyWare.

HD77 Module parameters

1. Use Babyware to configure the system: module names, labels, zones, partition assignments, arming settings etc.
2. Confirm that the IP address field contains the correct IP address. If not use the IP Exploring tool.

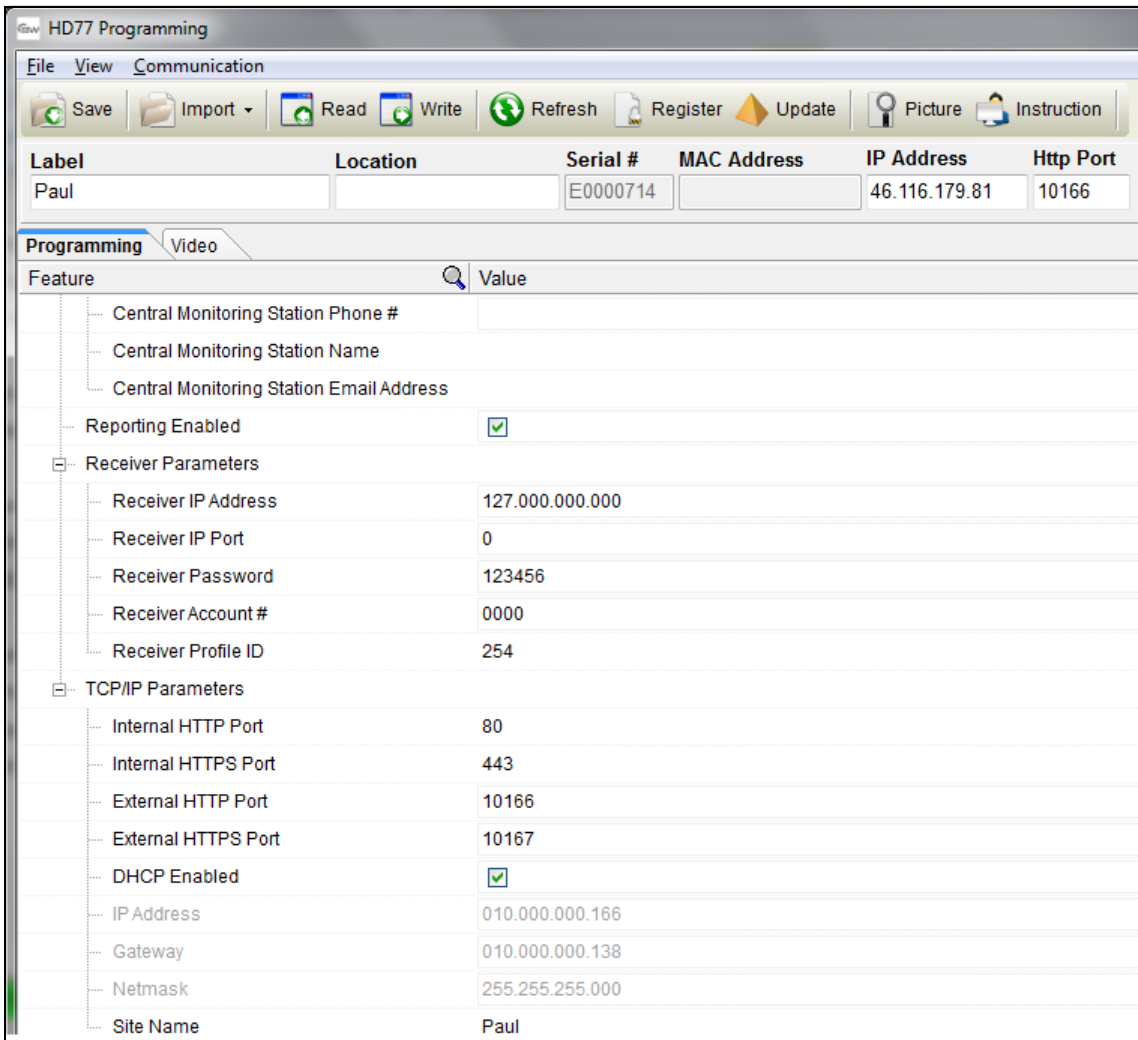

Figure 25 – Server Parameters

PIR Programming Through the TM50 touchpad

Only PIR parameters for the HD77 can be configured through the touchpad.

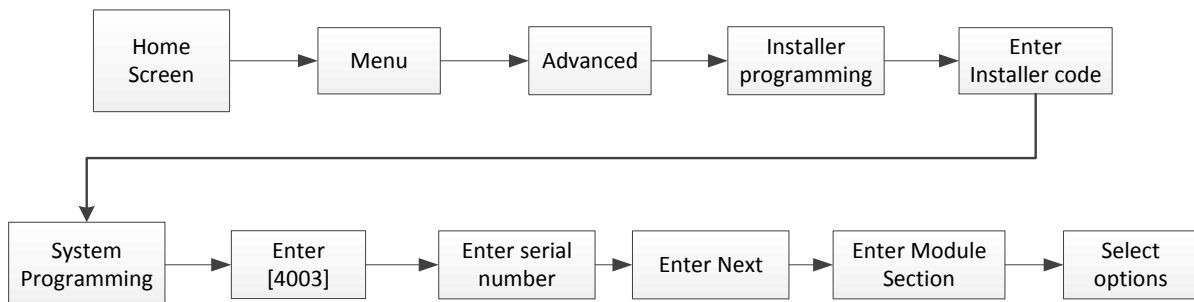

Figure 26 – Flow through the TM50 Touchscreen

1. Select the **[Menu]** key.

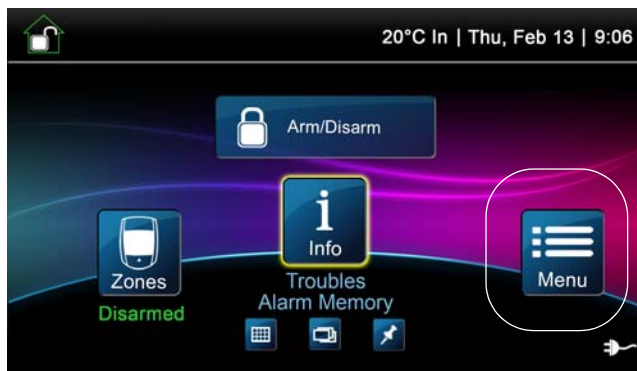

Figure 27 – Main Screen

2. Select the **[Advanced]** key.



Figure 28 – Menu Selections Screen

3. Select the **[Installer Programming]** key.



Figure 29 – Advanced Screen

4. Enter your [Installer Code].



Figure 30 – Installer Code

5. Select the [System Programming] key.



Figure 31 – Installer Programming Screen

6. Key in Section [4003].



Figure 32 – Installer Programming Screen

7. Enter the module's [Serial Number]. Click **Next**.

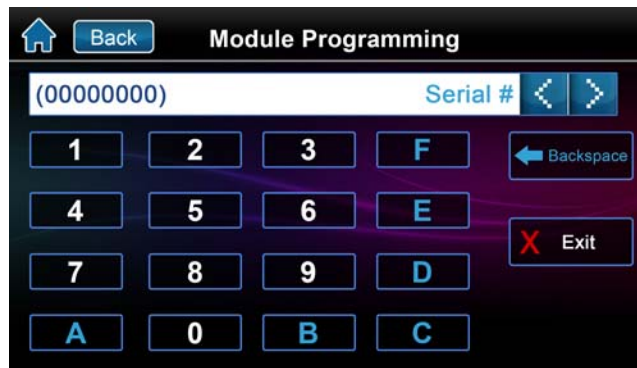

Figure 33 – Module Serial Number Screen

8. Enter Section [001].

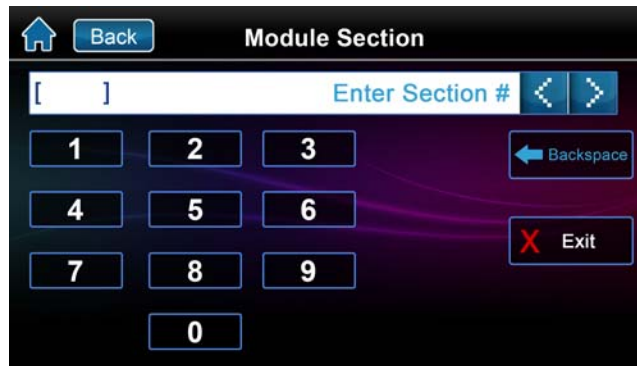

Figure 34 – Programming Section

9. Option 1 is for PIR LED On/Off;
On – LED#3 is will light up Red when PIR motion is detected.
Off – LED#3 stays off when the PIR motion is detected.
Default is On.
Options 2 through 8 are not relevant for the HD77.



Figure 35 – Options Selection Screen

10. Enter Section [002].

11. Select PIR sensitivity level, level 1 to level 5 – Default is #3.

12. Enter Section [003].

13. Select PIR security level, level 1 to level 3 – Default is #1.

PIR Programming Through the K641+ keypad

Only PIR parameters for the HD77 can be configured through the touchpad.

1. Press and hold the [0] key. The installer will be asked to input his installer code.
2. Enter your [Installer Code]. The default installer code is 000000.
3. Key in Section [4003].
4. Enter the module's [Serial Number].
5. Enter Section [001].
6. Option 1 is for PIR LED On/Off; On – LED#3 is Red when PIR motion is detected. Off – LED#3 stays off when the PIR motion is detected.
Default is On
Options 2 through 8 are not relevant for the HD77.
7. Enter Section [002].
8. Select PIR sensitivity level, level 1 to level 5. Default is level 3.
9. Enter Section [003].
10. Select PIR security level, level 1 to level 3. Default is level 1.

PIR Settings

Description	Section	Setting	Setting Details	Example
1. PIR LED display	[001]	[1] Off [1] On	PIR LED Off PIR LED On	(1*****)
2. PIR Sensitivity	[002]	[1]	Low (Sensitivity level)	(001) 000-005
		[2]		
		[3]	Default	
		[4]		
		[5]	High (Sensitivity level)	
3 Security Level	[003]	[1] <i>Normal</i>	<i>(Mild environment)</i>	(001) 000-003
		[2]	Medium	
		[3]	High (Harsh environment)	

4.3 Registering your Customer's System with ParadoxMyHome

ParadoxMyHome is a Paradox Domain Name System (DNS) service that enables the user/installer to remotely access a Paradox Reporting Device (e.g. IP150 or HD77) connected to an Internet Service Provider that uses dynamic IP addresses. A dynamic IP address is assigned automatically, and can change on a regular basis. ParadoxMyHome keeps track of these changes and will associate it to a Site ID (e.g. John house). If you do not already have an account at ParadoxMyHome you will need to open one. Using any Browser go to ParadoxMyHome.com. Click on **Create Login**, and follow the directions.

4.3.1 Setting up ParadoxMyHome

Using the ParadoxMyHome service will allow you to access your system over the Internet with a dynamic IP address. The HD77 will then poll the ParadoxMyHome server to keep the information updated. To set up the ParadoxMyHome service:

1. Go to www.paradoxmyhome.com.
2. Click **Request Login** and provide the requested information.

4.3.2 Registering the HD77 to ParadoxMyHome

1. Start the Paradox IP Exploring Tools software and right-click the HD77.
2. Select Register to ParadoxMyHome (choose a site ID or use the one created for the IP150).

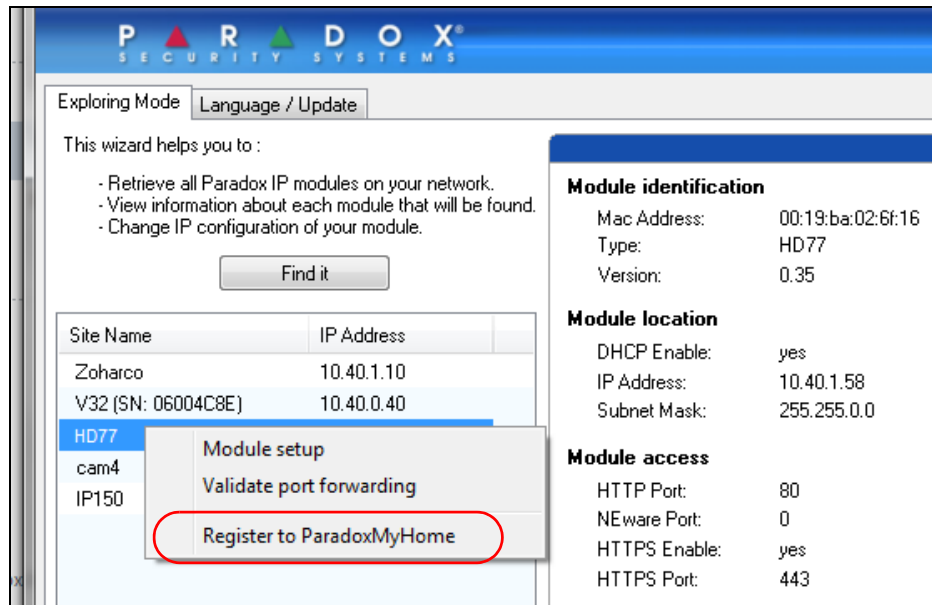

Figure 36 – IP Exploring Tool

3. Enter the requested information. The SiteID should be unique for the module.



Figure 37 – ParadoxMyHome Registration Page

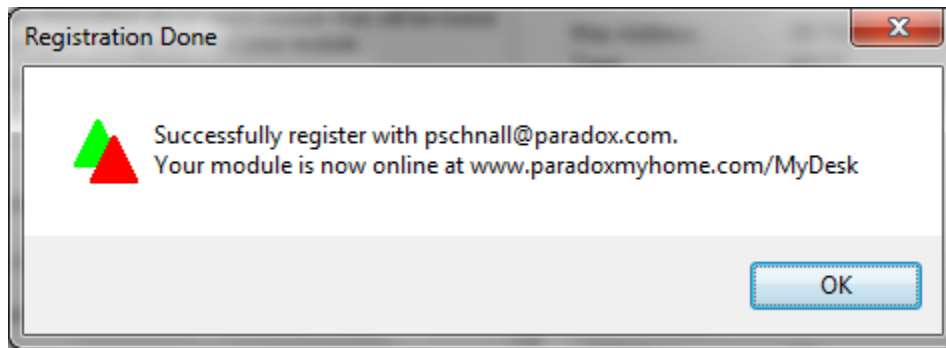

Figure 38 – Registration Successful

4. Ensure the HD77 has access to reach the public network.
5. Verify HD77 updated PMH with status, public IP and ports.

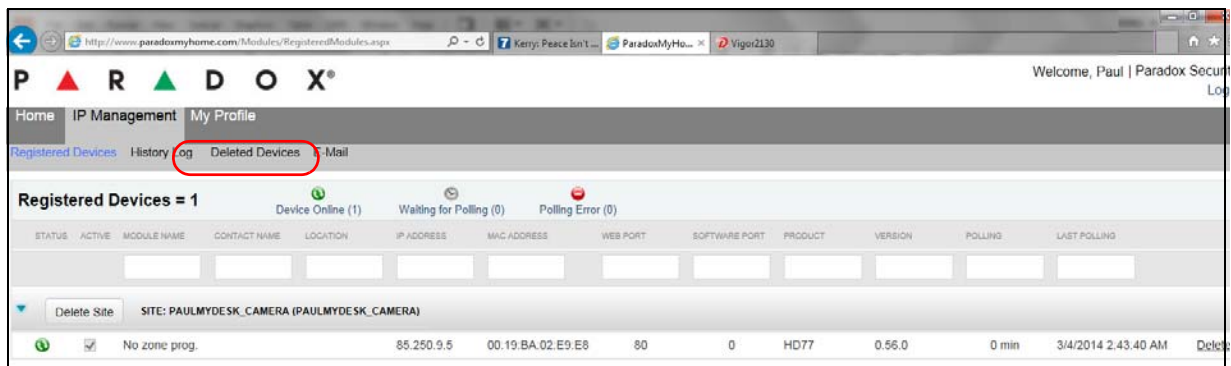

Figure 39 – ParadoxMyHome Site

4.3.3 Deleting a Site from PMH

When deleting a site from my PMH you may get an error message that the site still exists. If you delete a site from PMH on the registered devices page you then have to go to the Deleted devices page and delete it again from there. Or else PMH keeps the site just like the Windows recycle bin makes you empty your recycle bin after you have already deleted your file.

Note: To delete a site from PMH first delete the site from the Registered devices page and then delete it from the Deleted Devices page. You must delete your site from BOTH pages.

4.4 Upgrading Firmware

1. Use Babyware to upgrade firmware on all of HD77s on your site. To update FW on the HD77 you will need BabyWare V2.5 or higher.
2. Double click on any connected HD77 module listed in BabyWare.

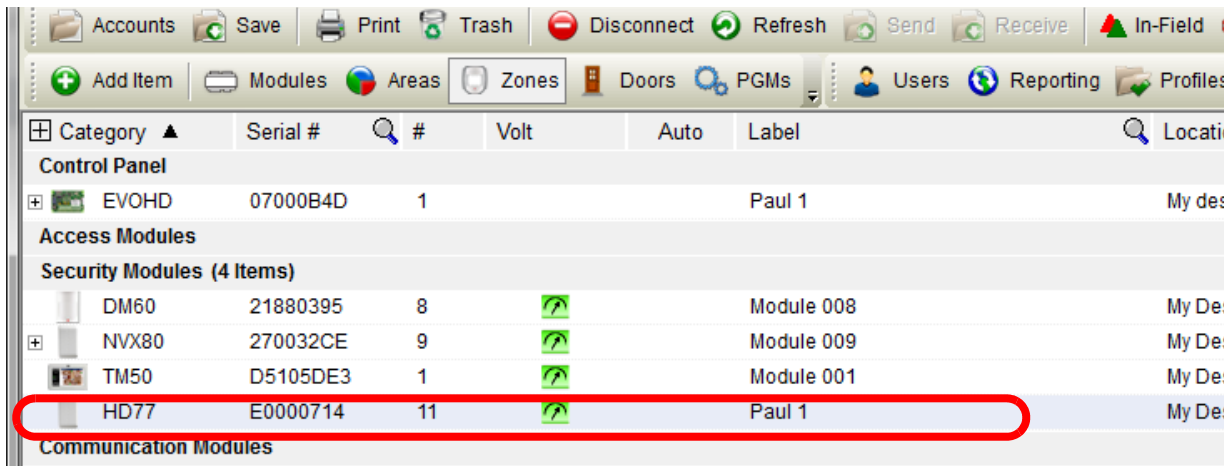

Figure 40 – Select HD77

3. On the HD77 programming page click **Update**.

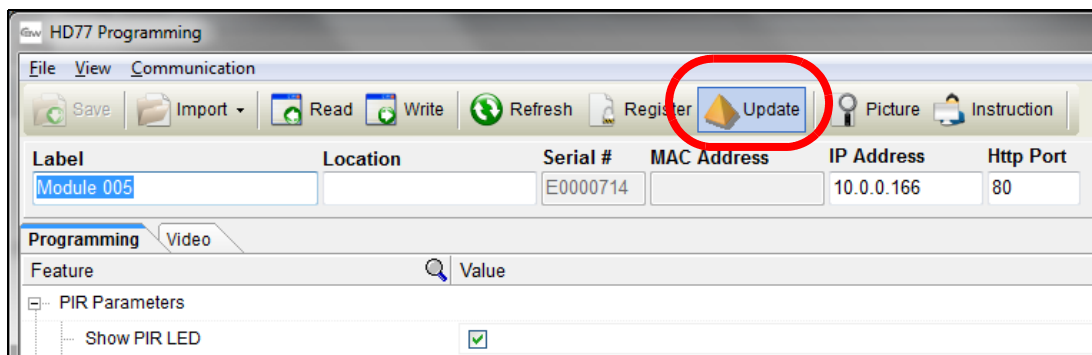

Figure 41 – Update button

The following window opens up.

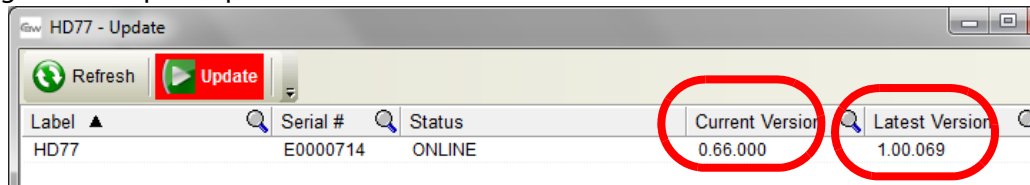

Figure 42 – Click Update

4. Click Update in this window. This will take a few minutes.
5. In order to see if the FW upgrade was successful, after the camera boots up you will need to disconnect and reconnect to BabyWare. You can also close down and restart BabyWare.

Insight Application Configuration

After installing the Insight application on your smart phone, the application will start in the “System Settings” screen.

1. Enter the desired site label, provide a valid site ID [Registered to ParadoxMyHome] (as provided by your installer), and a server password (default: paradox).
2. Tap “OK”, if the communication to the site was validated, you will be able to proceed and click “Next”.
3. The new site will appear on the dashboard, showing its status, and allowing you to login using your security system user code (the same one you use to turn off the alarm system when you get in to your home or business).

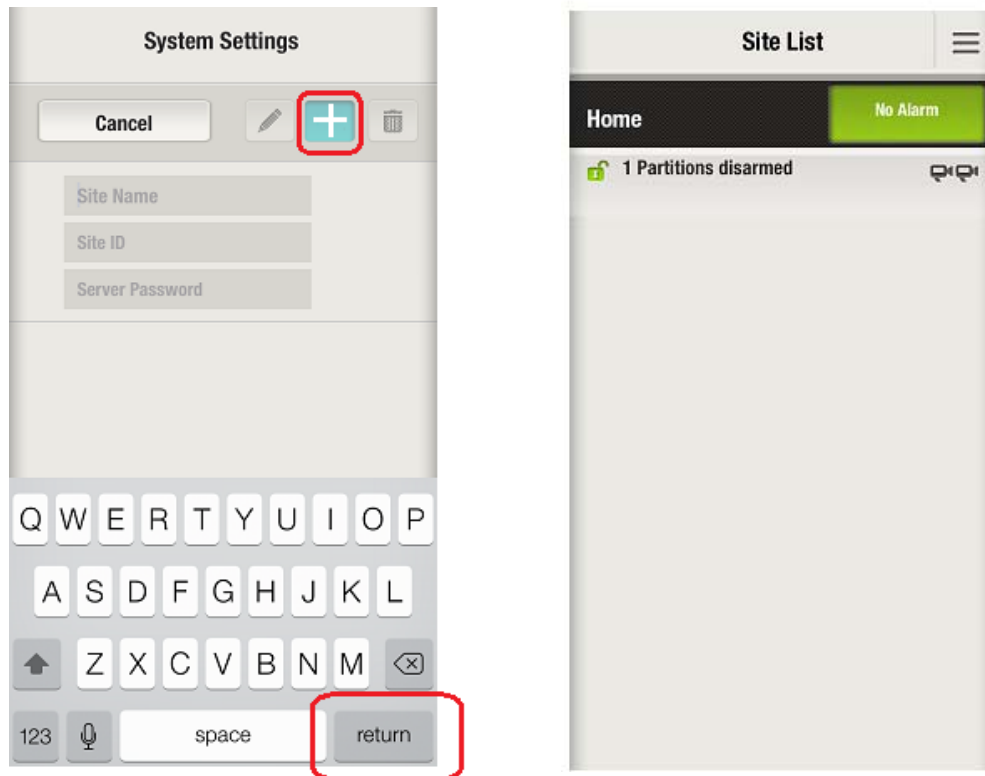

Figure 43 – System Settings

Appendix: A Specifications

HD77 Specifications

Image sensor type	1.4 Mega pixel, CMOS sensor
Voltage input	Nominal: 12VDC, range 9-16VDC
Current consumption	330 mA RMS
Installation Height	2.1 m - 2.7 m (7 ft - 9 ft)
Installation Options	Wall or corner, optional swivel bracket
Coverage	12 m x 12 m (40 ft x 40 ft) / 110°
PIR Type	Quad PIR, Auto pulse, Auto dual edge, Digital detector
Micro SD card size	4GB
Camera recording resolution	720p
Streaming video resolution	360p
Video on Demand recording time	2 minutes each
Number of VOD files stored	~ 12 files
Alarm/Motion recording time	10 seconds each
Pre-Event Recording	3 seconds prior to PIR activation / alarm
Number of alarm/motion files that can be saved on the Micro SD card	~40 files
PIR and video linked files	The file naming conventions link the PIR file with its corresponding video file
Detection speed	0.2 m/s to 2.5 m/s (0.6 ft/s to 11.5 ft/s)
Angle of view (Camera)	62.7° (V) x 91.4° (H) x 121.4° (D)
Video Image Resolution	1280 x 720 pixels
Facial Identification	4.5 meters
Facial Recognition	7 meters
Streaming Video	360p H.264 10 FPS
Audio	16 bit, 16KHz sampling rate, 32Kb/s mono
Physical Size	(H x W x D)15 cm x 7.5 cm x 5 cm (6 in x 3 in x 2 in)
Environmental	See the Paradox.com website for the latest certifications for this product.
Operating temperature	-10° C to +55° C (14° F to 131° F)

Appendix: B PIR Detector Beam Pattern

The beam pattern for the Detector is shown below.

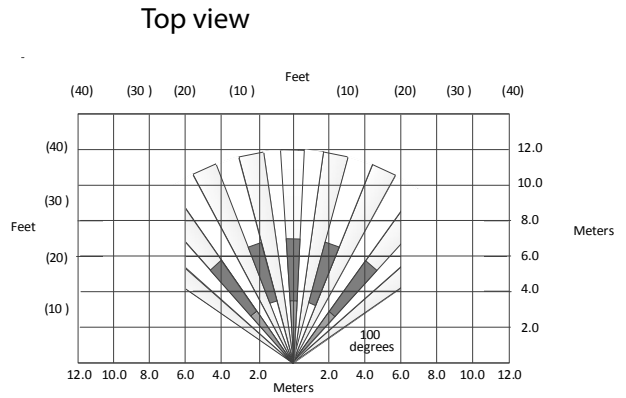
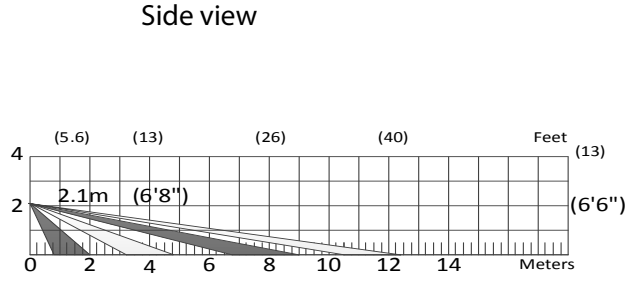

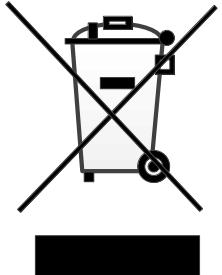

Figure 44 – PIR Detector Beam Pattern

Note: EN 50131 testing has been performed for 100 degrees

Appendix: C Certifications

Mark/	Area/Country	level/Grade/Class
	European Economic Area (EEA)	
	European Economic Area (EEA)	WEEE
	European Economic Area (EEA)	EN 50131-2-2 Grade 2 Environmental Class II

Appendix: D Unassemble Swivel Bracket

This swivel bracket is capable of:

- sweep angle from left to right of 90 degrees
- angle of declination (up and down) is 15 degrees.

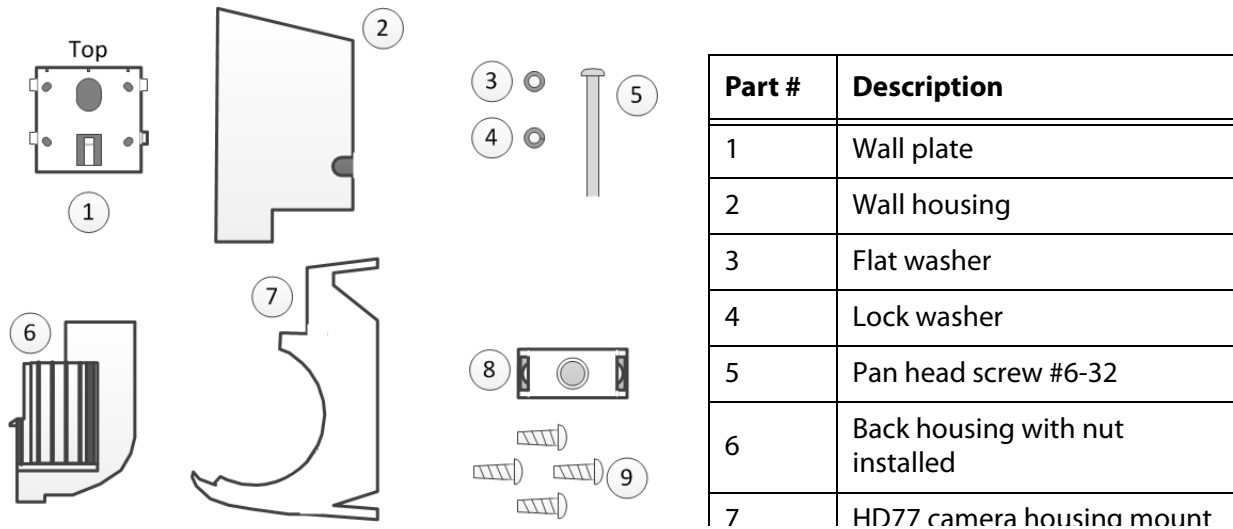

Figure 45 – HD77 Swivel Bracket Parts

Disassemble Swivel

Remove the pan head screw

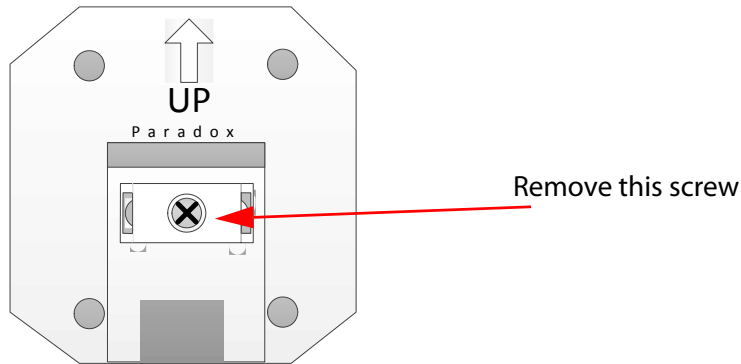

Figure 46 – Assembled Swivel Bracket

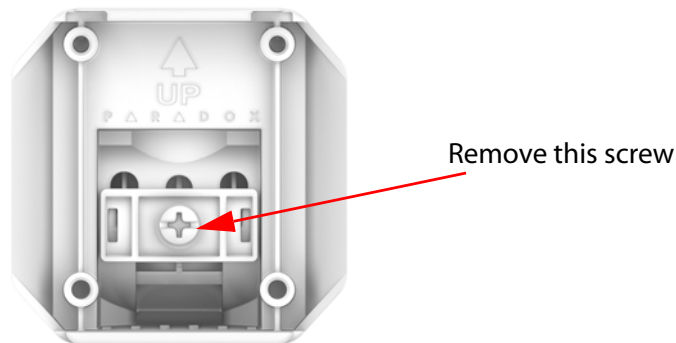

Figure 47 – Assembled Swivel Bracket

Do not drop the flat washer or the lock washer.

The two swivel sections remain connected. It is possible to separate the two swivel sections if necessary.

swivel (part #6)
and part 2

HD77 camera housing mount
(part 7)

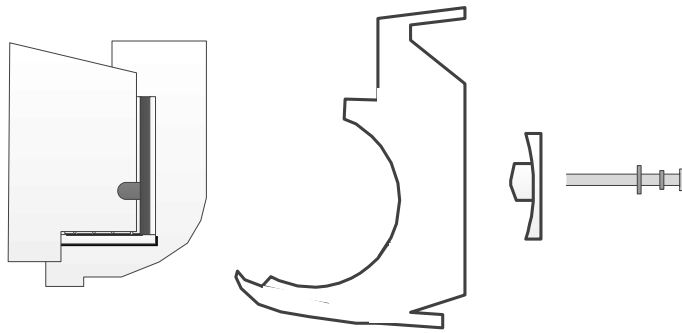

slider and
pan head
screw with
washers
(parts 3, 4, 5,
and 8)

Figure 48: Screw the Slider, HD77 Camera Housing and Back Housing Together

swivel (part #6)
and part 2

HD77 camera housing mount
(part 7)



slider and
pan head
screw with
washers
(parts 3, 4, 5,
and 8)

Figure 49: Screw the Slider, HD77 Camera Housing and Back Housing Together

1. Unlock the cover of the camera.
2. Separate the Module from the back cover of the HD77 by carefully pulling out and sliding up.
3. Assemble the swivel mount.

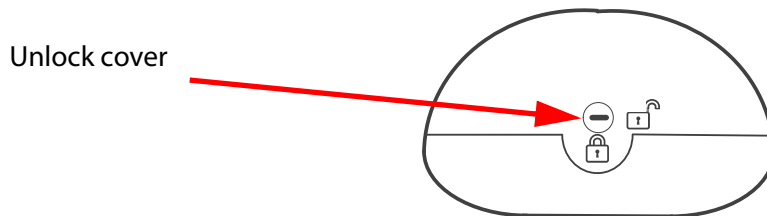

Figure 50: Separating the Module from the Camera Housing



Figure 51: Separating the Module from the Camera Housing

- Step 1. Pull the cable(s) through the wall plate (part #1) and screw the wall plate to the wall (screws and anchors are not supplied). The upper screws must be at least 3"(7.62cm) from the ceiling.

- Step 2. Pull the cables through the wall housing (part #2).
- Step 3. Attach the wall housing to the wall plate.

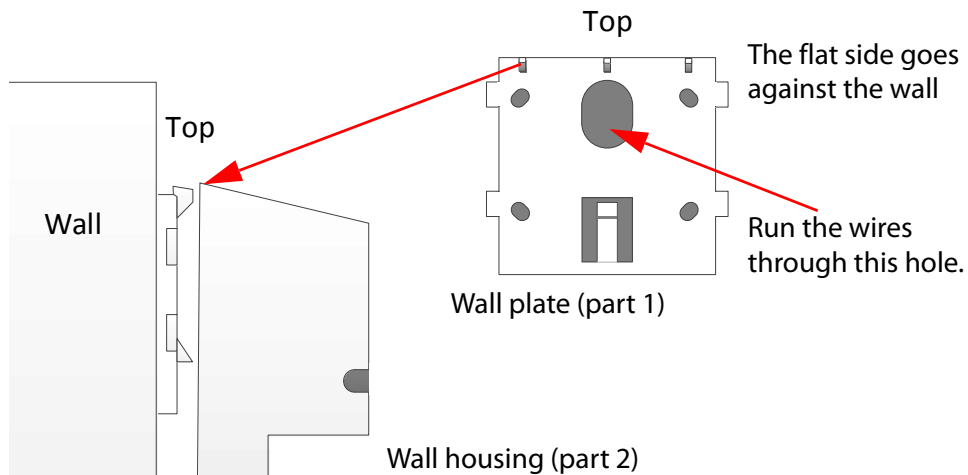

Figure 52: Install the Wall Plate (part #1) and Wall Housing (part #2)

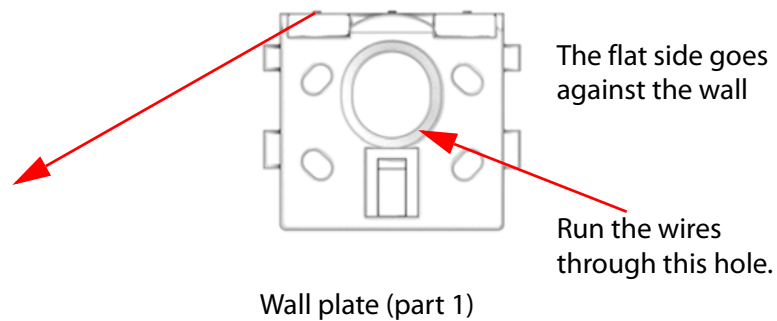

Figure 53: Install the Wall Plate (part #1) and Wall Housing (part #2)

- Step 4. Using the pan head screw with the lock washer and flat washer, connect the slider (part #8) and the HD77 camera housing mount (part #7) to the back housing (part #6).
- Step 5. Tighten the pan head screw.

back housing (part #6) HD77 camera housing mount (part #7)

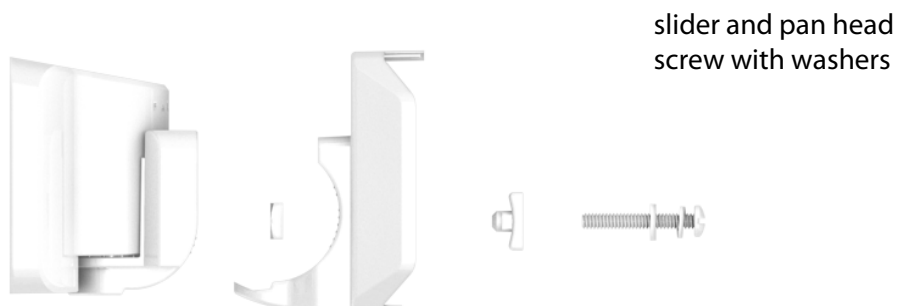

Figure 54: Screw the Slider, HD77 Camera Housing and Back Housing Together

Step 6. Pull the cables through the assembled swivel bracket.

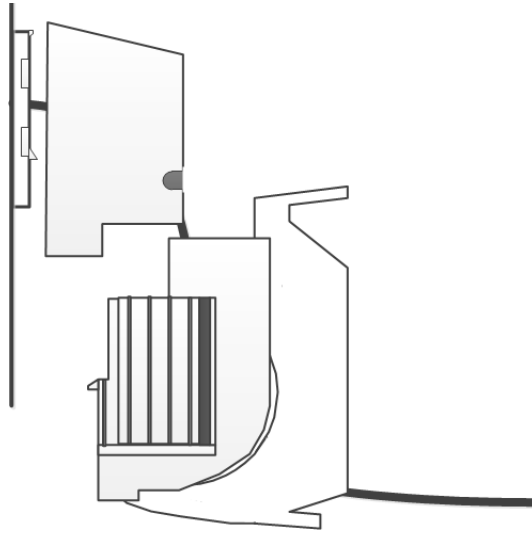

Figure 55: Run the Cable through the Swivel Assembly

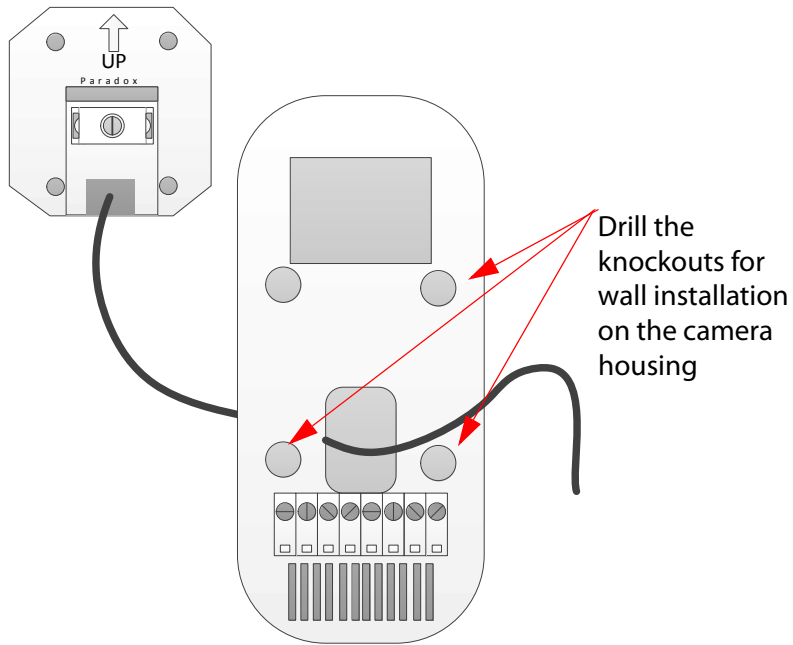
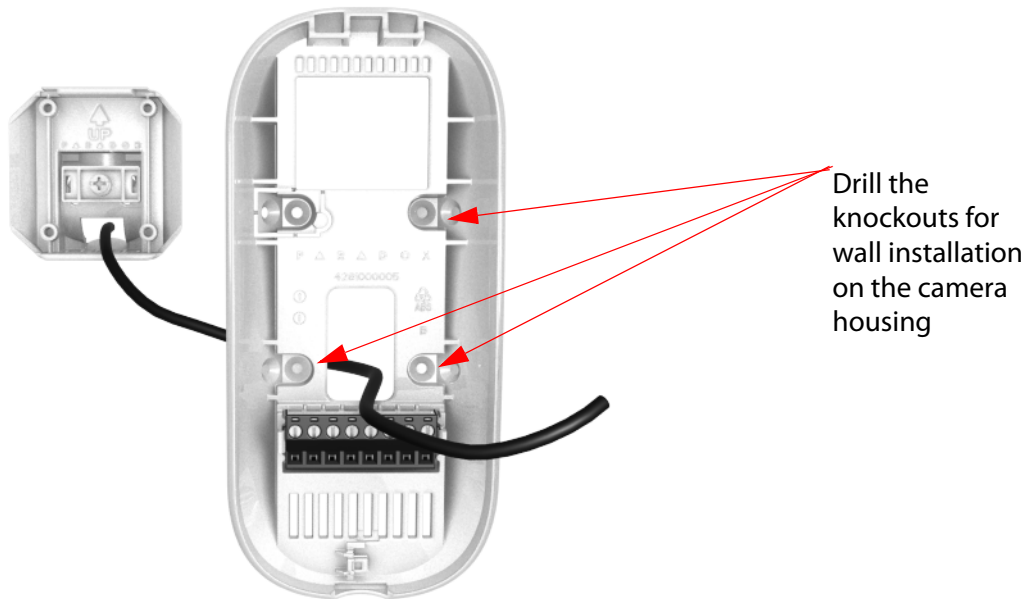

Figure 56 – Screw on Camera Back Plate to Swivel.



- Step 7. Screw on Camera Back Plate to Swivel. Drill the knockouts for wall installation on the camera housing.
- Step 8. Write the serial number of the module into your module table. Include the exact location of this module. If you are using BabyWare the serial number will be displayed, but you will need to write down the correct location for each module according to the serial number.
- Step 9. Screw the HD77 back plate to the housing mount using the 4 self tapping screws.

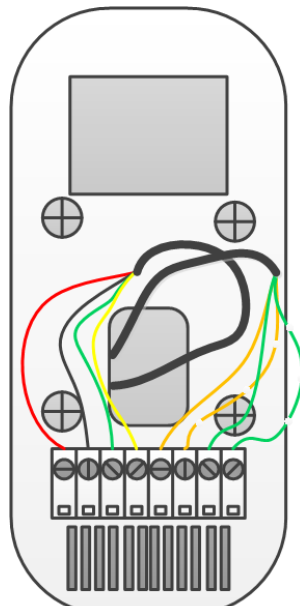

Figure 57 – Wire the Camera

Figure 58 – Wire the Camera

Step 10. Connect the combus wires and the Ethernet wires. See *Figure 13* and *Figure 14* for wiring instructions.

Note: Slack wire should not interfere with closing the cover.

4. Close and lock the camera into the camera housing:

Step 1. Install the top of the unit first.

Step 2. Close the HD77 onto the back plate.

Step 3. Close the lock mechanism at the bottom of the device. (note that by securing the lock, the technician indication LEDs will be turned off).

5. Connect the Ethernet line to the router (if not already connected). Make sure the router is turned on.

Step 1. Adjust the camera position and confirm camera view using Babyware.

P ▲ R ▲ D O X™

The whole Paradox team wishes you a successful and easy installation.
We hope this product performs to your complete satisfaction.
Should you have any questions or comments, please contact us.

For support, please contact your local distributor, or dial +1-450-491-7444,
Monday to Friday, from 8:00 a.m. to 5:00 p.m. EST.
You may also e-mail us at support@paradox.com.
Additional information can be found at PARADOX.COM

Printed in Canada

HD77-EI01



paradox.com